

HEATING INSULATION INCLUDED

Thickness: 45 mm

FRAME PLATE

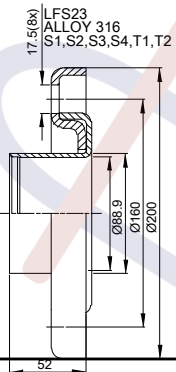
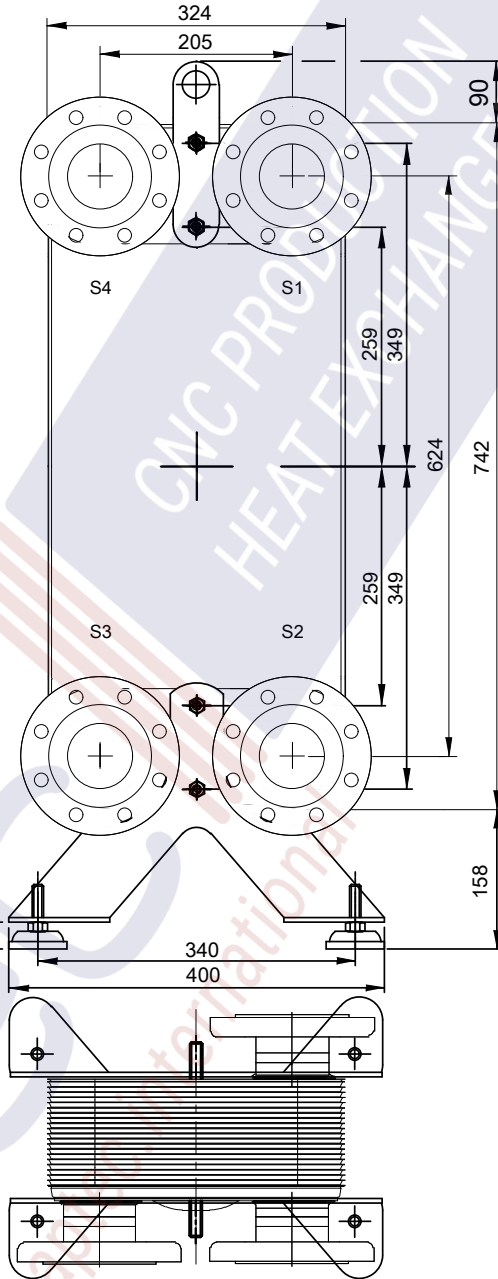
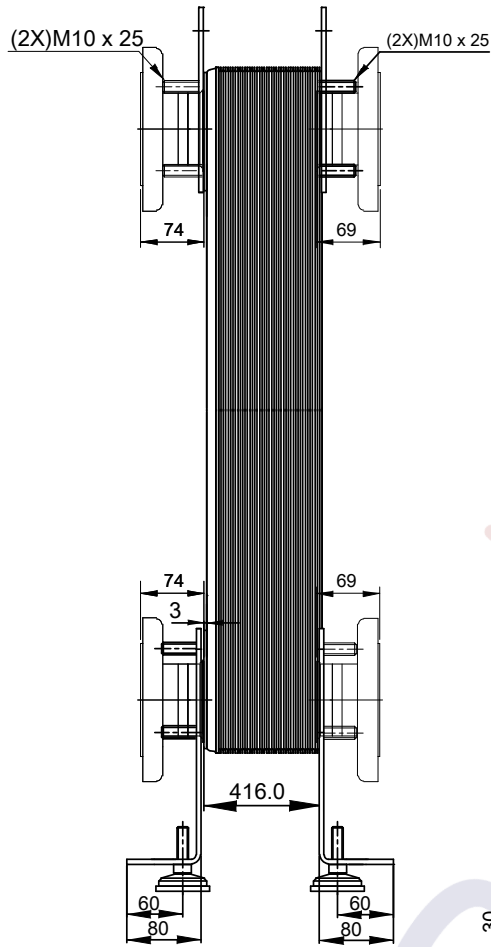

HEATING SURFACE m²
 NETWEIGHT 117.0 kg
 OPERATING WEIGHT kg
 PLATE MATERIAL ALLOY 316
 PLATE GROUPING 1*74ML/1*75MH

T1 T2 T3 T4 locations on back side correspond to S1 S2 S3 S4 on front side

ALL DIMENSIONS IN MILLIMETERS

SIDE	MEDIA	INLET	TEMP. °C	OUTLET	TEMP. °C	FLOW RATE	PRESSURE DROP	LIQUID VOL.
1	Water	S1	°C	S2	°C	kg/h	kPa	38.3 dm ³
2	Water	S3	°C	S4	°C	kg/h	kPa	37.7 dm ³

Note that all unique customer requirements (i.e tolerance) need to be verified thru Alfa Laval.

PRESSURE VESSEL APPROVAL

PED

CB200-150M (3287184052)

www.alfalaval.com

CUSTOMER NAME / REF. NO.

COMPANY / REF.
Aptec production s.r.o.

TOTAL LENGTH 576 mm
 TOTAL WIDTH 324 mm
 TOTAL HEIGHT 990 mm



7/8/2020
REV 0