

HEATING INSULATION INCLUDED
Thickness: 45 mm

FRAME PLATE

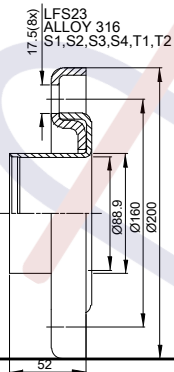
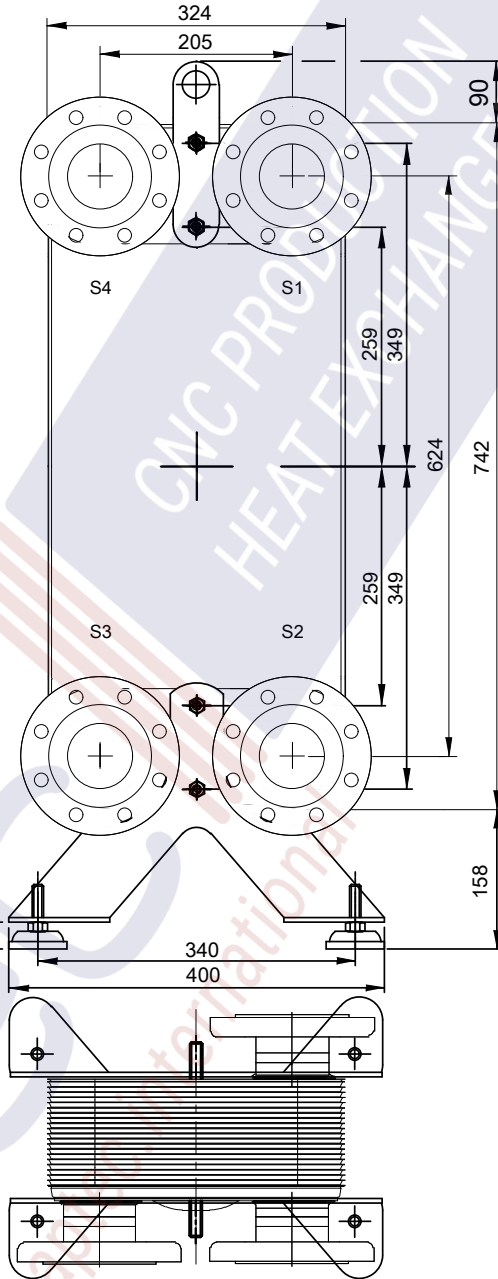
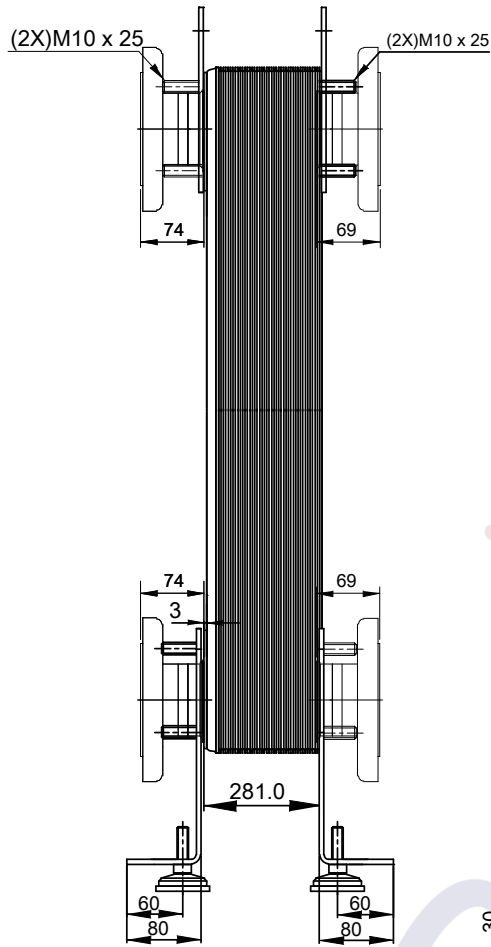

HEATING SURFACE m²
 NETWEIGHT 87.0 kg
 OPERATING WEIGHT kg
 PLATE MATERIAL ALLOY 316
 PLATE GROUPING 1*49H/1*50H

T1 T2 T3 T4 locations on back side correspond to S1 S2 S3 S4 on front side

ALL DIMENSIONS IN MILLIMETERS

SIDE	MEDIA	INLET	TEMP. °C	OUTLET	TEMP. °C	FLOW RATE	PRESSURE DROP	LIQUID VOL.
1	Water	S1	°C	S2	°C	kg/h	kPa	25.5 dm ³
2	Water	S3	°C	S4	°C	kg/h	kPa	25.0 dm ³

Note that all unique customer requirements (i.e tolerance) need to be verified thru Alfa Laval.

PRESSURE VESSEL APPROVAL

PED

CB200-100H (3287184043)

www.alfalaval.com

CUSTOMER NAME / REF. NO.

COMPANY / REF.
 Aptec production s.r.o.

TOTAL LENGTH 441 mm
 TOTAL WIDTH 324 mm
 TOTAL HEIGHT 990 mm



7/8/2020
 REV 0