

Note that all unique customer requirements (i.e tolerance) need to be verified thru Alfa Laval.

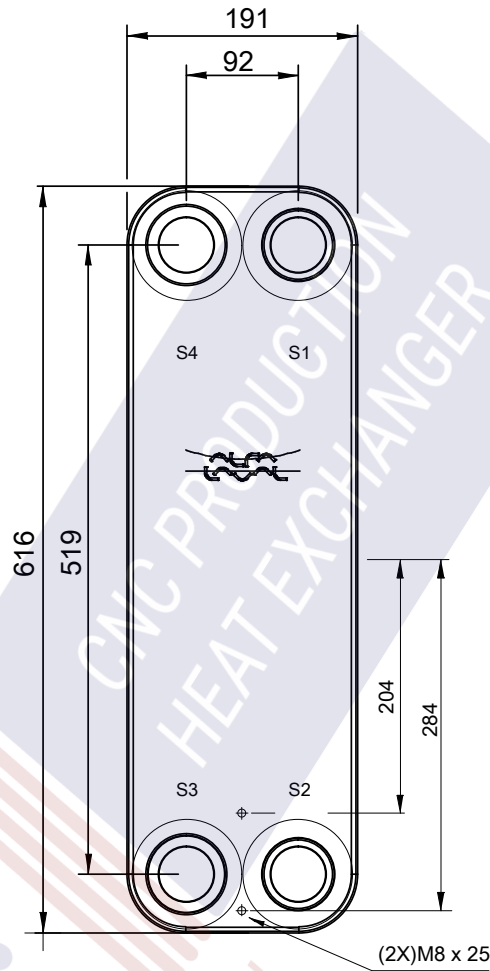

T1 T2 T3 T4 locations on back side correspond to S1 S2 S3 S4 on front side

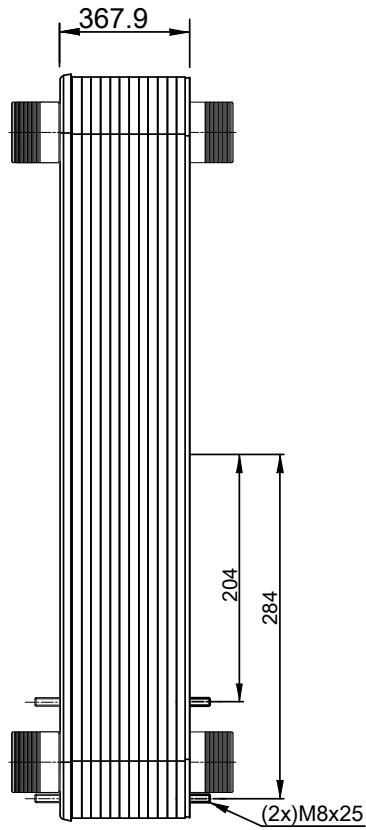
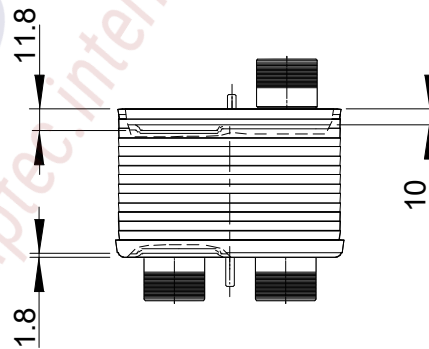
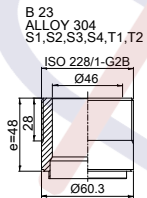

HEATING SURFACE m<sup>2</sup>  
 NETWEIGHT 66.4 kg  
 OPERATING WEIGHT kg  
 PLATE MATERIAL ALLOY 316  
 PLATE GROUPING 1\*84H/1\*85H

ALL DIMENSIONS IN MILLIMETERS

SIDE	MEDIA	INLET	TEMP. °C	OUTLET	TEMP. °C	FLOW RATE	PRESSURE DROP	LIQUID VOL.
1	Water	S1	°C	S2	°C	kg/h	kPa	15.3 dm <sup>3</sup>
2	Water	S3	°C	S4	°C	kg/h	kPa	15.1 dm <sup>3</sup>

PRESSURE VESSEL APPROVAL PED

CB112-170H-F (3287184171)

www.alfalaval.com

CUSTOMER NAME / REF. NO.

TOTAL LENGTH 454 mm  
 TOTAL WIDTH 191 mm  
 TOTAL HEIGHT 616 mm

COMPANY / REF.  
 Aptec production s.r.o.



7/8/2020  
 REV 0