

Note that all unique customer requirements (i.e tolerance) need to be verified thru Alfa Laval.

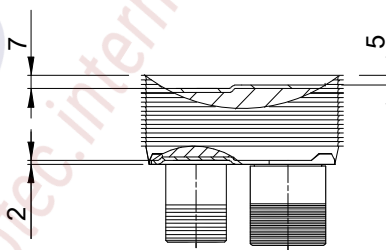
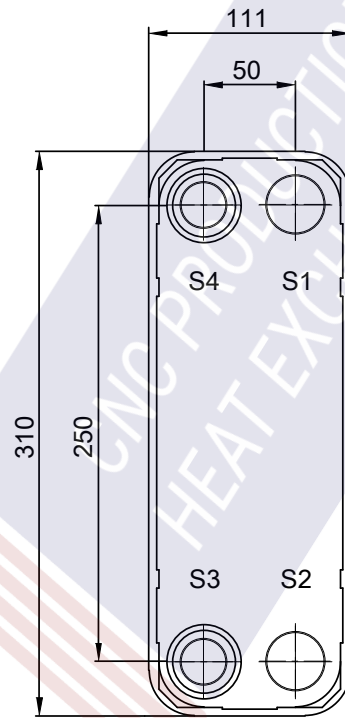
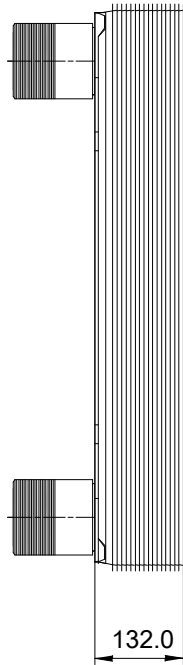
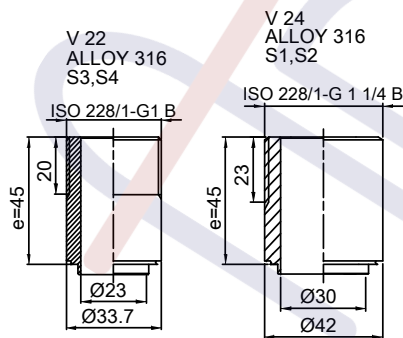

HEATING SURFACE m²
 NETWEIGHT 8.3 kg
 OPERATING WEIGHT kg
 PLATE MATERIAL ALLOY 316
 PLATE GROUPING 1*24H/1*25H

Frameplate is depressed 2 mm at connection S3/S4
 Pressureplate is depressed 2 mm / even number of channel plates
 at connections T3/T4 / uneven number of channel plates at
 connections T1/T2.

T1 T2 T3 T4 locations on back side
 correspond to S1 S2 S3 S4 on front side

ALL DIMENSIONS IN MILLIMETERS

SIDE	MEDIA	INLET	TEMP.	OUTLET	TEMP.	FLOW RATE	PRESSURE DROP	LIQUID VOL.
1	Water	S1	°C	S2	°C	kg/h	kPa	1.3 dm ³
2	Water	S3	°C	S4	°C	kg/h	kPa	1.2 dm ³

PRESSURE VESSEL APPROVAL

PED

AlfaNova 27-50H (3288000970)

www.alfalaval.com

CUSTOMER NAME / REF. NO.

TOTAL LENGTH 177 mm
 TOTAL WIDTH 111 mm
 TOTAL HEIGHT 310 mm

COMPANY / REF.
 Aptec production s.r.o.



7/8/2020
 REV 0