

HEATING INSULATION INCLUDED

Thickness: 45 mm

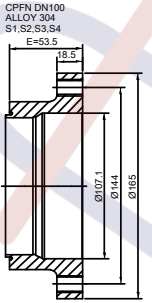
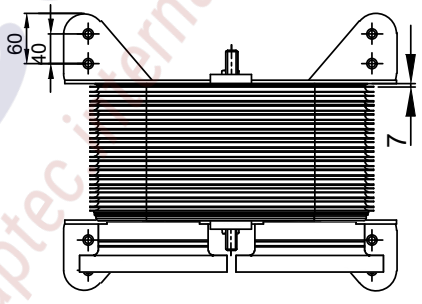
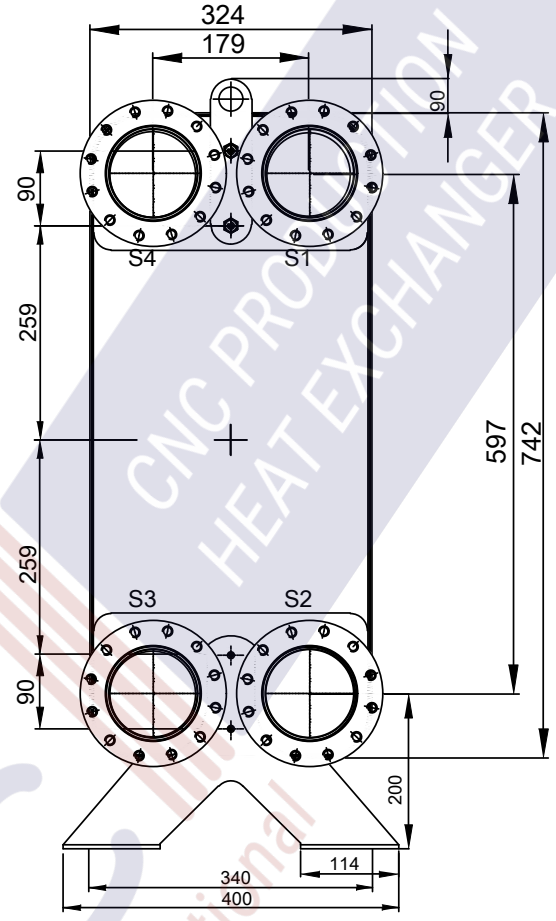
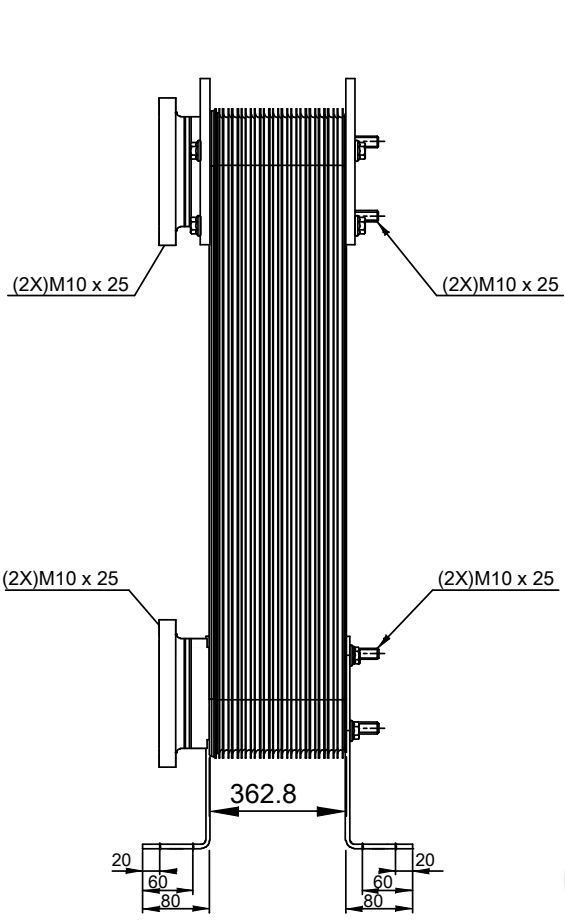

T1 T2 T3 T4 locations on back side correspond to S1 S2 S3 S4 on front side

HEATING SURFACE m²
 NETWEIGHT 125.0 kg
 OPERATING WEIGHT kg
 PLATE MATERIAL ALLOY 316
 PLATE GROUPING 1*79H/1*80H

ALL DIMENSIONS IN MILLIMETERS

SIDE	MEDIA	INLET	TEMP. °C	OUTLET	TEMP. °C	FLOW RATE	PRESSURE DROP	LIQUID VOL.
1	Water	S1	°C	S2	°C	kg/h	kPa	40.2 dm ³
2	Water	S3	°C	S4	°C	kg/h	kPa	39.7 dm ³

Note that all unique customer requirements (i.e tolerance) need to be verified thru Alfa Laval.

PRESSURE VESSEL APPROVAL PED/UK
 CBH210-160H-F (3075097866)



www.alfalaval.com

CUSTOMER NAME / REF. NO. COMPANY / REF. Aptec production s.r.o. Aptec production s.r.o. 176008	TOTAL LENGTH 523 mm TOTAL WIDTH 324 mm TOTAL HEIGHT 959 mm	2/8/2024 REV 0

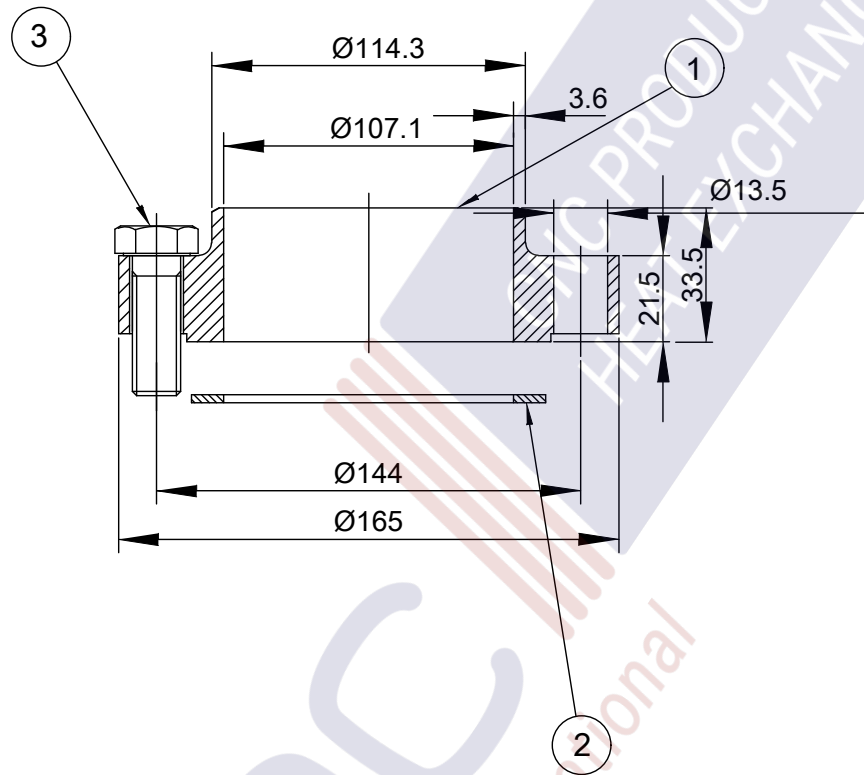

12	3		BOLT M6S M12x35	Stainless steel	
1	2		GASKET 132x107x1.5	REINZ AFM-34	
1	1		FLANGE DN100 PN35	Carbon steel	Type FC
Qty	item		Name/Designation	Material	Notes



3456325106

1x DN100 CS Counter CPF

www.alfalaval.com

{CUSTOMER NAME / REF. NO}

COMPANY / REF.
Aptec production s.r.o.
Aptec production s.r.o. 176008

2/8/2024