

Note that all unique customer requirements (i.e tolerance) need to be verified thru Alfa Laval.

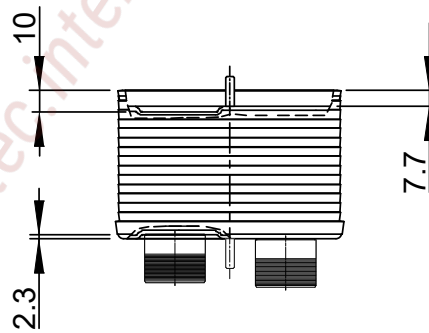
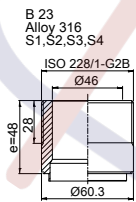
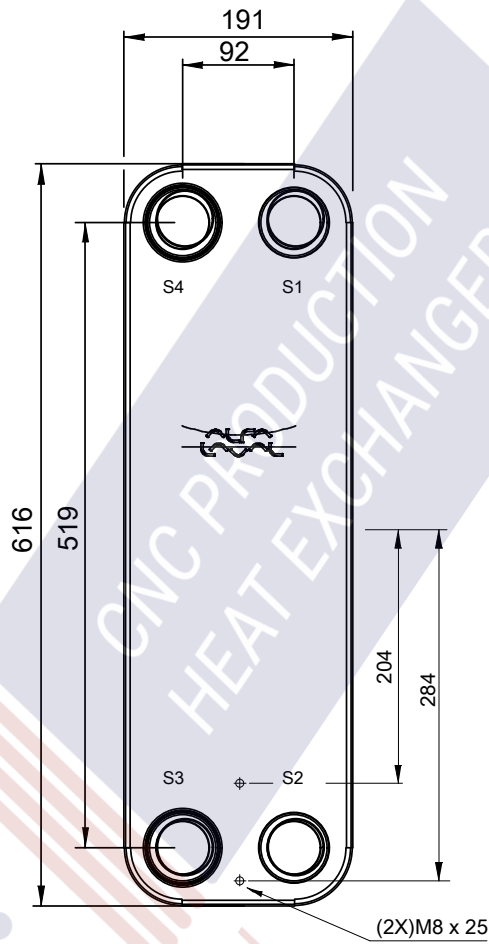
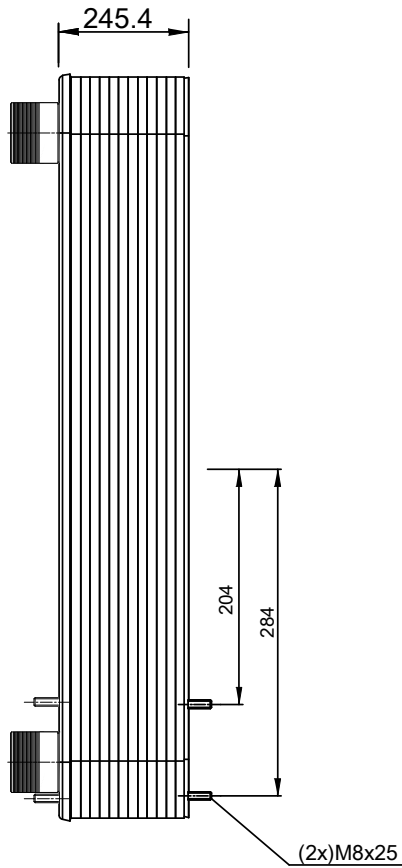

HEATING SURFACE
 NETWEIGHT 37.9 kg
 OPERATING WEIGHT
 PLATE MATERIAL Alloy 316
 PLATE GROUPING 1*44ML/1*45MH

ALL DIMENSIONS IN MILLIMETERS

SIDE	MEDIA	INLET	TEMP.	OUTLET	TEMP.	FLOW RATE	PRESSURE DROP	LIQUID VOL.
1								9.24 dm ³
2								9.45 dm ³

PRESSURE VESSEL APPROVAL

PED

CB110-90M (3287101596)

www.alfalaval.com

CUSTOMER NAME / REF. NO.

COMPANY / REF.

TOTAL LENGTH 308.4 mm
 TOTAL WIDTH 191.0 mm
 TOTAL HEIGHT 616.0 mm



6/28/2021
 REV 0