

Note that all unique customer requirements (i.e tolerance) need to be verified thru Alfa Laval.

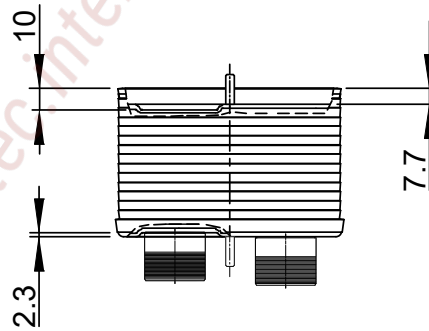
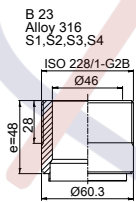
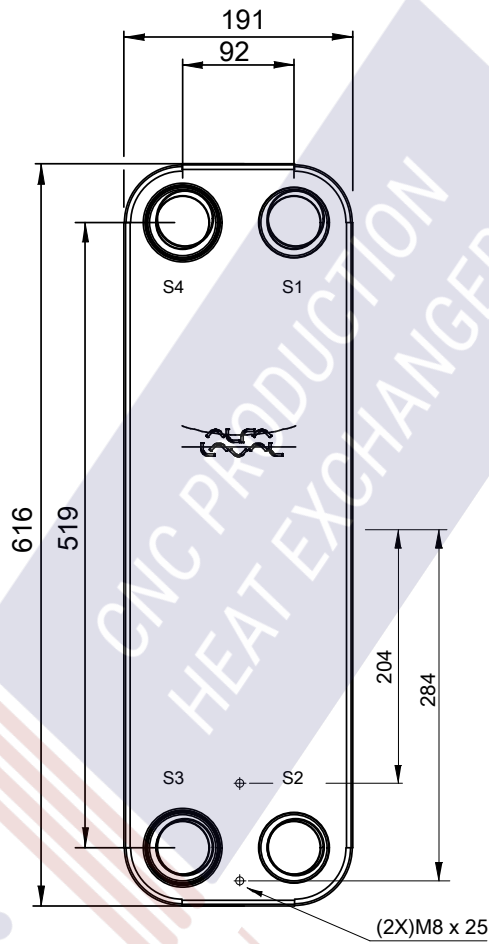
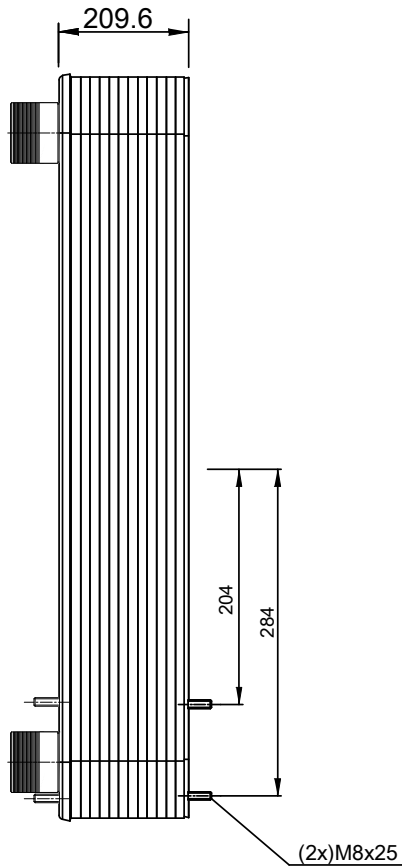

HEATING SURFACE
 NETWEIGHT 33.0 kg
 OPERATING WEIGHT
 PLATE MATERIAL Alloy 316
 PLATE GROUPING 1*37H/1*38H

ALL DIMENSIONS IN MILLIMETERS

SIDE	MEDIA	INLET	TEMP.	OUTLET	TEMP.	FLOW RATE	PRESSURE DROP	LIQUID VOL.
1								7.77 dm ³
2								7.98 dm ³

PRESSURE VESSEL APPROVAL

PED

CB110-76H (3287101561)

www.alfalaval.com

CUSTOMER NAME / REF. NO.

TOTAL LENGTH 272.6 mm
 TOTAL WIDTH 191.0 mm
 TOTAL HEIGHT 616.0 mm

COMPANY / REF.



6/28/2021
 REV 0